

dansk radio aktieselskab

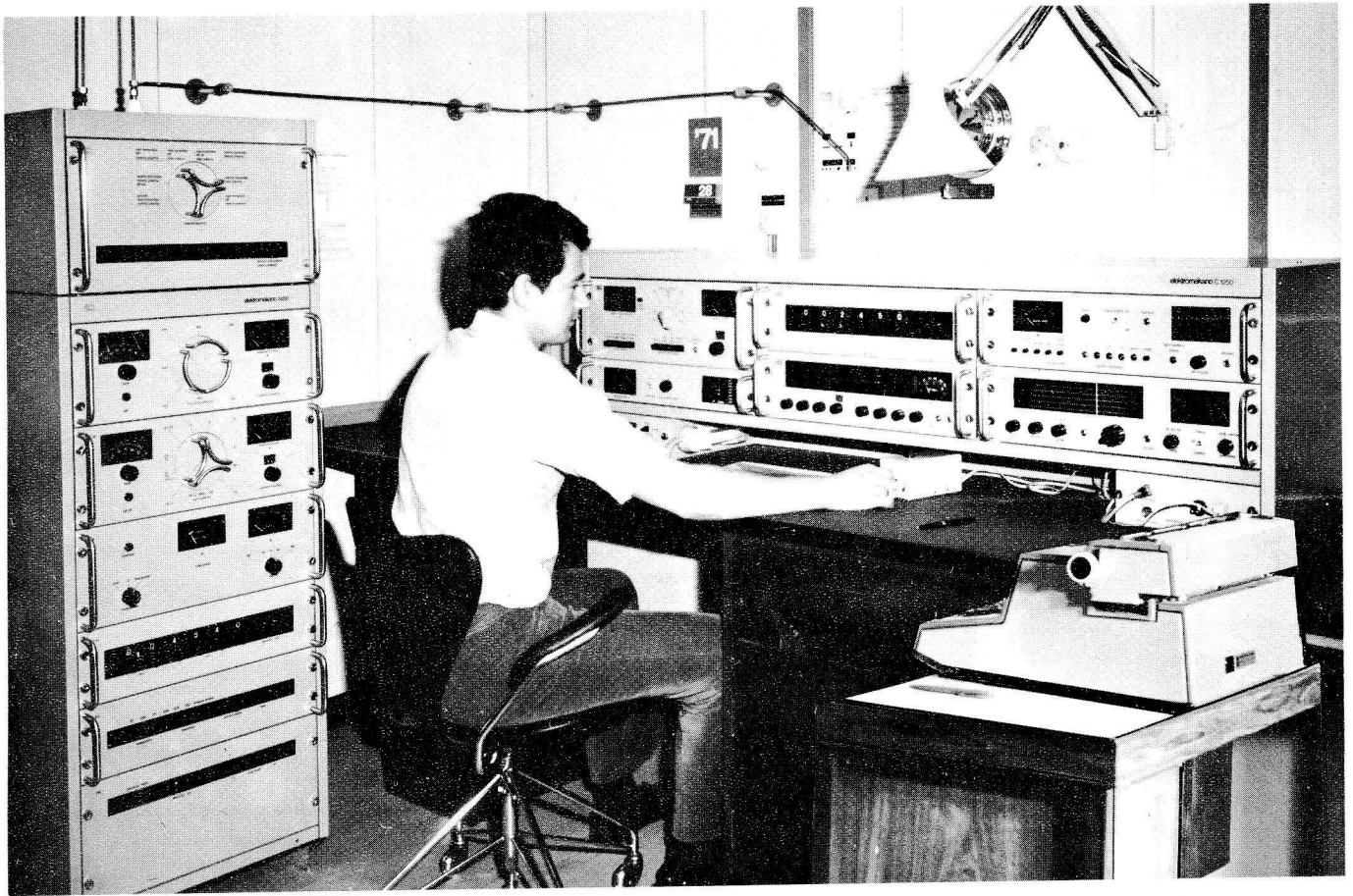

radio-console

elektromekano C1250

containing:

- synthesizer-controlled SSB main receiver type M 1250
- reserve transmitter type S 125
- reserve receiver type M 125
- auto alarm type A 125
- control panel type K 125

Complying with the applicable rules
in the Radio Regulations, Geneva 1967,
and SOLAS, London 1960

Dansk Radio Aktieselskab
33, Amaliegade, DK-1256 Copenhagen K, Denmark
telephone (01) 13 13 33
telegrams.: Dariose
telex 27058

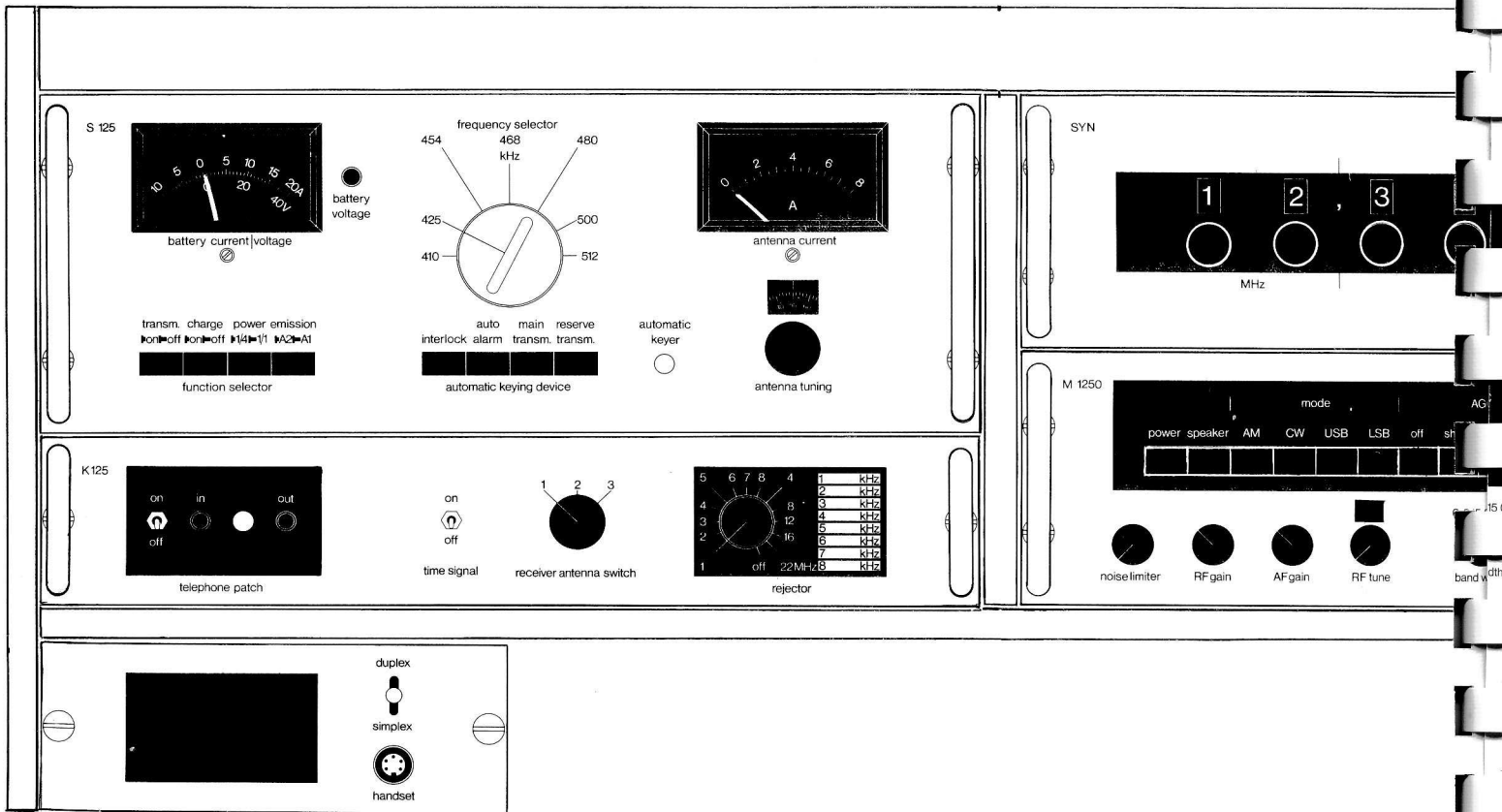

elektromekano C1250

elektromekano C1250

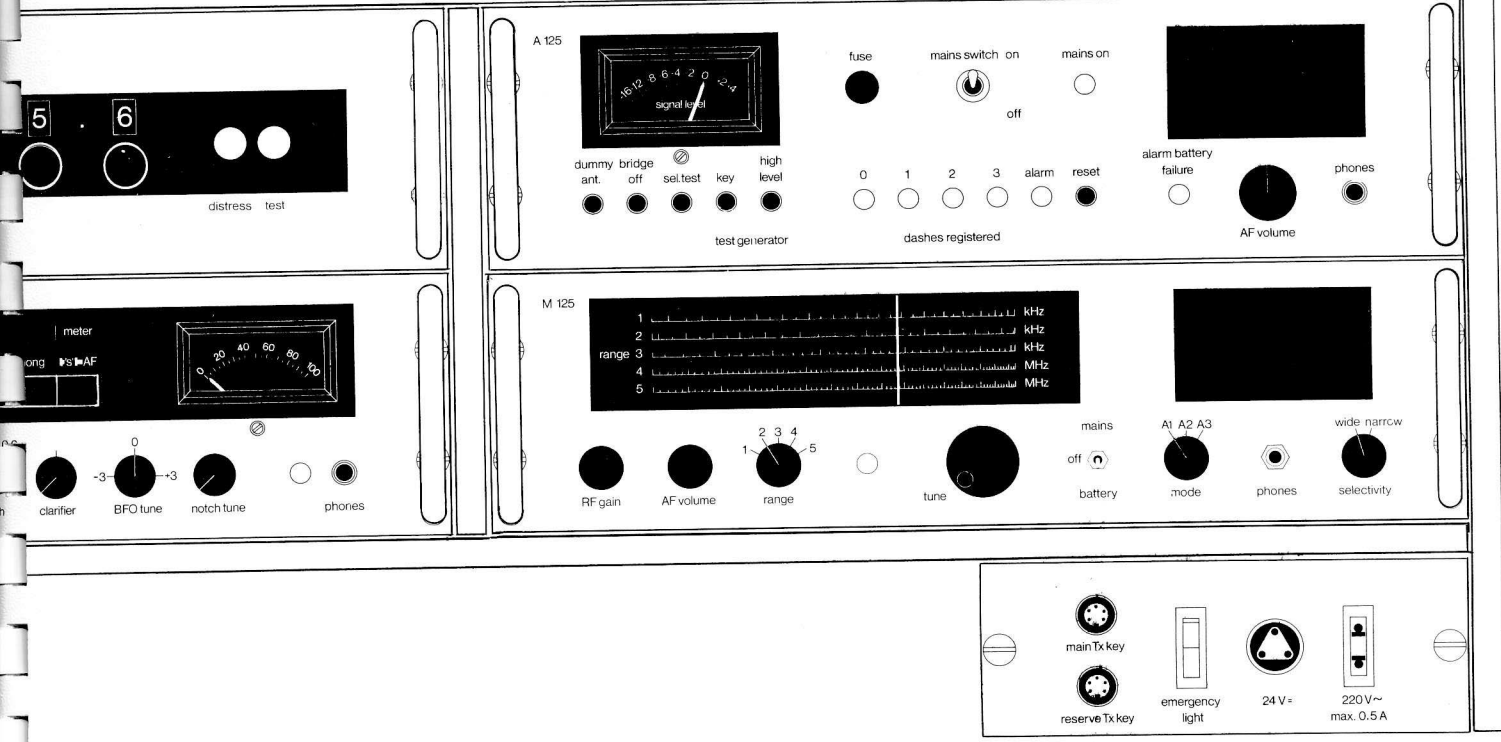

DIMENSIONS AND WEIGHT:

Height: 430 mm
 Width: 1550 mm
 Depth: 510 mm
 Weight: approx. 100 kg

Outline and Mounting Dimensions C 1250 (H 1250)

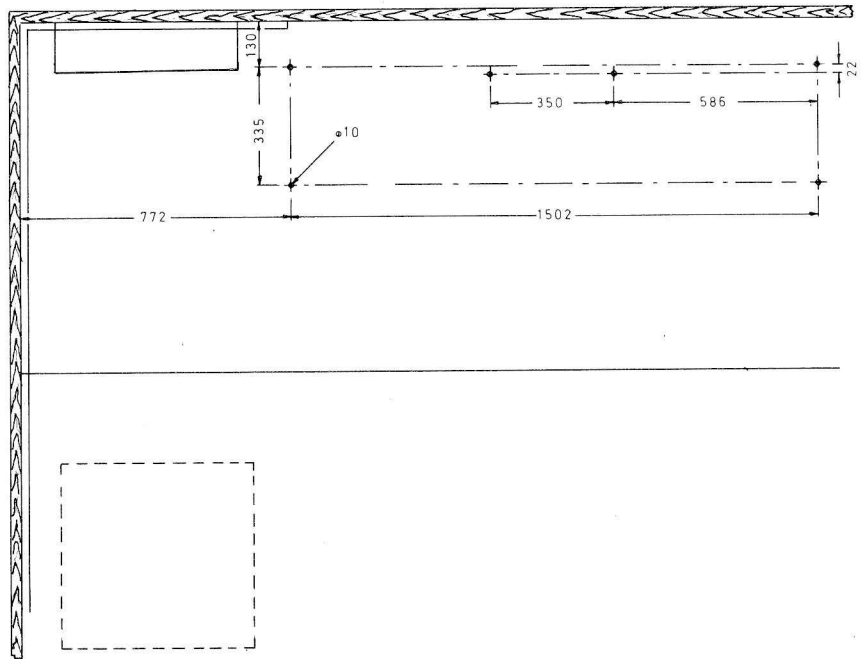
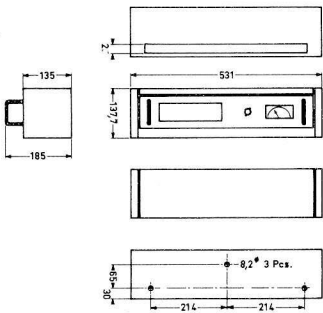
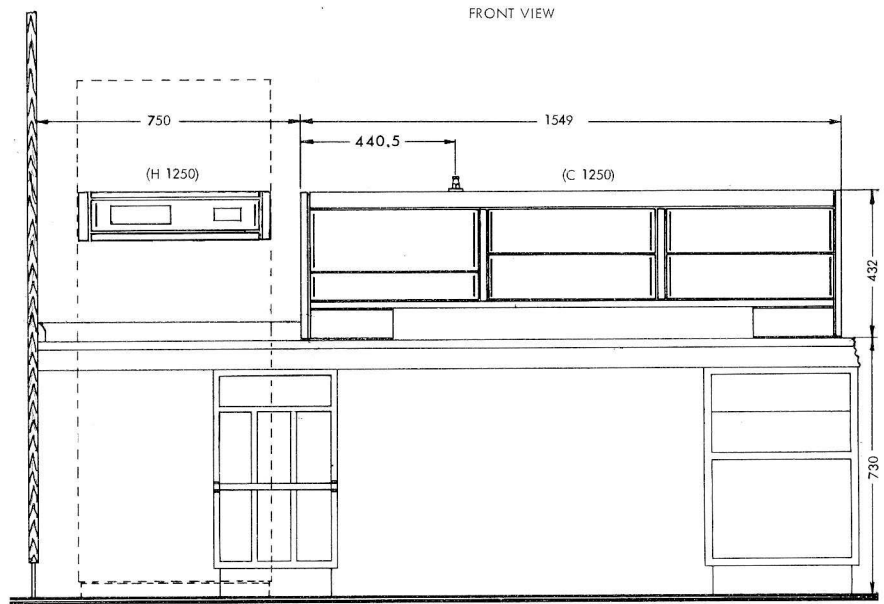
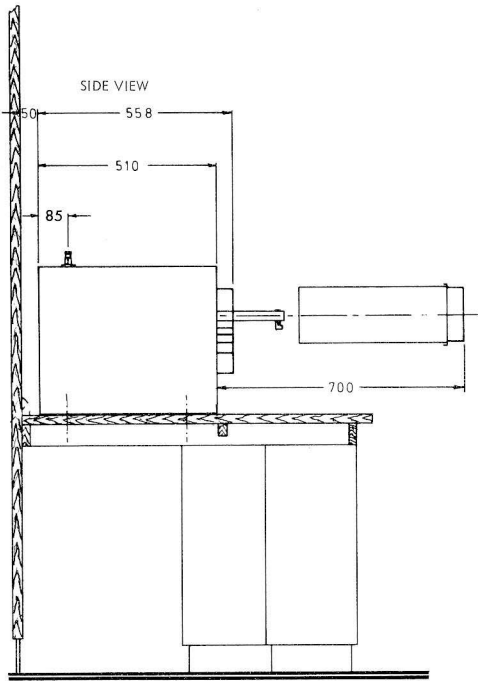

All dimensions are in mm (NTS)

COMPLETE MARINE RADIO INSTALLATIONS ● RADIOTELEPHONE EQUIPMENT FOR SMALLER VESSELS ● MARINE RECEIVERS ● AUTO ALARMS
 DIRECTION FINDERS ● AUTOMATIC ALARM SIGNAL KEYS ● PORTABLE LIFEBOAT EQUIPMENT ● MOTOR LIFEBOAT EQUIPMENT
 SALINOMETER FOR FRESHWATER GENERATORS ● MEASURING INSTRUMENTS ● ECHO SOUNDERS FOR VERTICAL AND HORIZONTAL USE
 RADAR EQUIPMENT ● LORAN EQUIPMENT ● ANTI INTERFERENCE AERIAL EQUIPMENT FOR RADIO AND TV ● LOUDHAILER EQUIPMENT
 VHF MARINE TELEPHONE EQUIPMENT ● MAST AND ROD AERIALS ● FACSIMILE RECORDERS FOR WEATHER CHARTS. Please write for further details